



GEOVENT

FAN

LSFG/MSFG 146 to 250 – and LSX/MSX ATEX versions

GEOVENT centrifugal fan LSFG and MSFG with forward curving impeller is used for extraction within the industry or for comfort ventilation, depending on the variant. The fan is made of 100% galvanized steel for optimum corrosion resistance and therefore, it is suitable for outdoor installation on the roof or on the wall. There is a complete program of accessories, and the fan can be delivered with a number of options, such as flex connection, mountings, rain shield, motor protection, pressure monitor and soundproof box. As standard we supply supporting angels with vibration absorbers, inlet nozzle with net and clamp for mounting the outlet flange.

The fan is also supplied in ATEX version according to the 94/9/EF directive. Then the type is called LSX/MSX, and it is supplied as standard with EExE motor. Other variants are offered on inquiry.

On inquiry it is possible to deliver the fan with built-in frequency converter, two-speed motor, with 6- or 8- poled motors, motors with special voltage or higher efficiency, special high temperature version a.s.o.

Air volume up to: 4.900 m³/h

Pressure up to: 1.840 Pa



Technical data / Other data / Features

Motor: Directly driven by a B5-Flange motor. Sealing class IP-55
Voltage: 3x400V or 1x230V / 50 Hz

3 of the fans sides can be used as mounting flange.

Made of hot-galvanized sheet metal.
All screws and bolts are electro galvanized.

Inclusive supporting angels with vibration absorbers, inlet nozzle with net and clamp for mounting the outlet flange.



Pressure loss - LSGG/LSX

The fans ampere usage is based on 3x400V motors. When 1x230V motors (Fan sizes 146-225) are used, it is possible to use a factor on about 2.7 to get the approximate ampere usage (may vary depending on model)

The air measurements are made without using an outlet flange on the outlet side and by a temperature on 20°C. The pressure lost measured in Pascal indicate the static pressure.

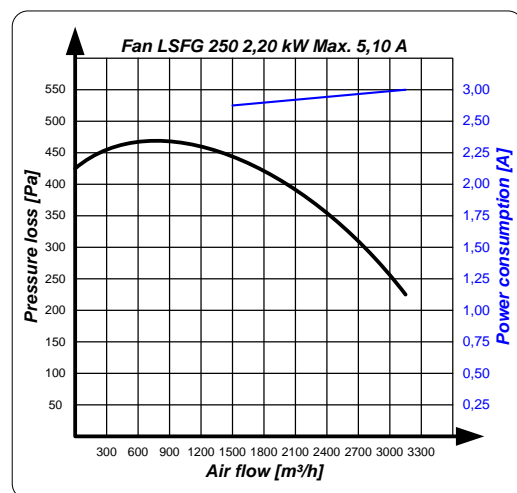
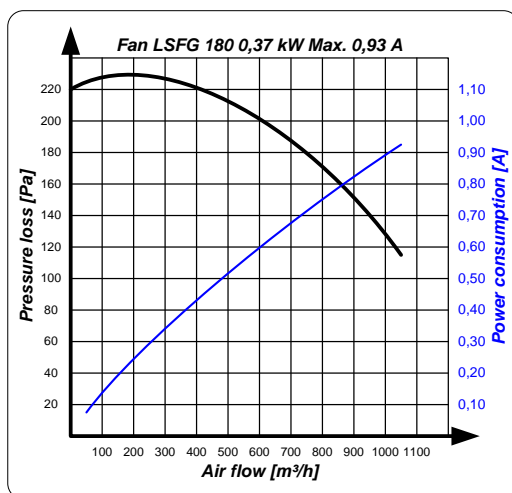
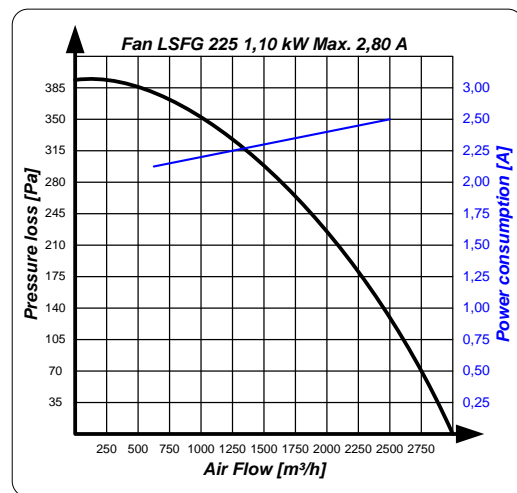
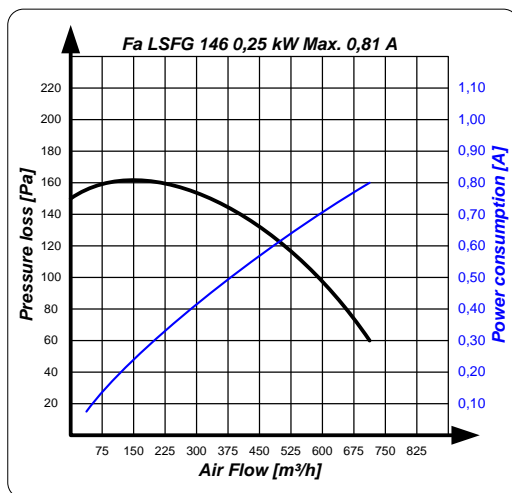
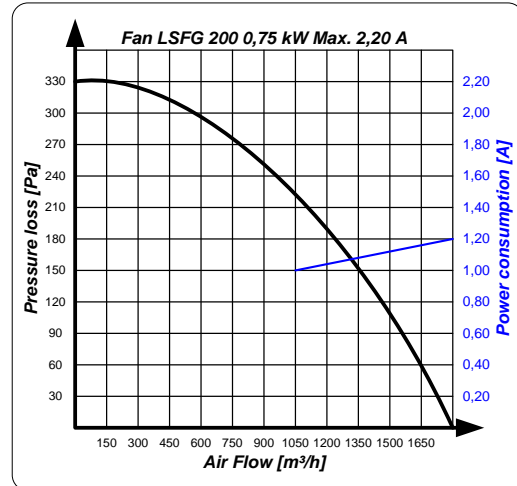



Pressure loss - MSFG/MSX

The fans ampere usage is based on 3x400V motors. When 1x230V motors (Fan sizes 146-200) are used, it is possible to use a factor on about 2.7 to get the approximate ampere usage (can vary depending on model).

The air measurements are made without using an outlet flange on the outlet side and by a temperature on 20°C. The pressure drop measured in Pascal indicate the static pressure.

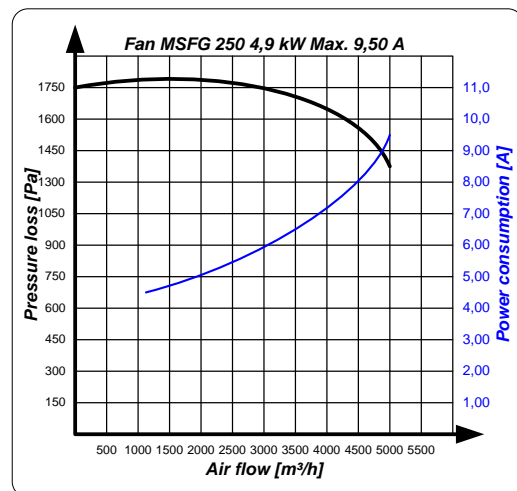
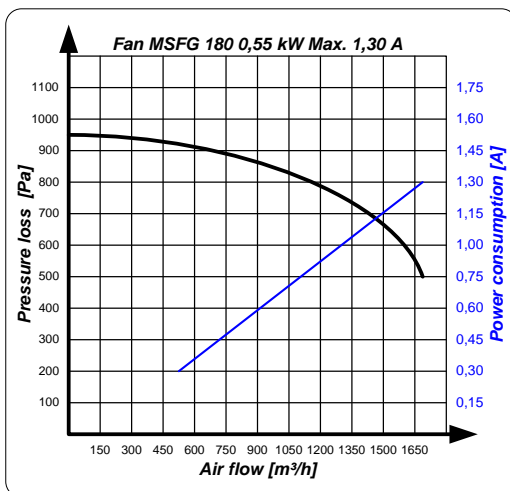
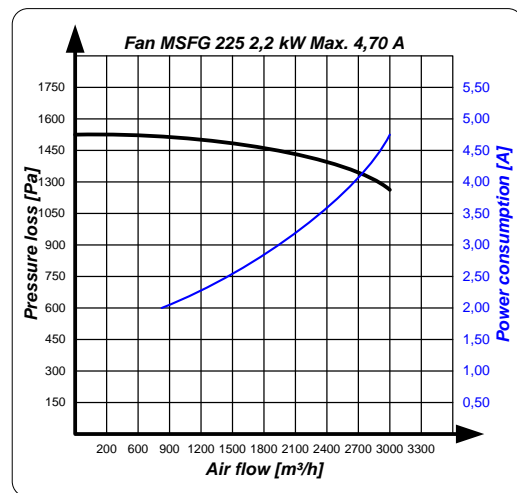
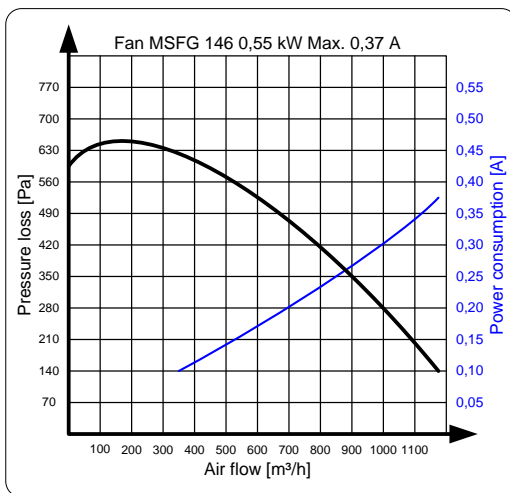
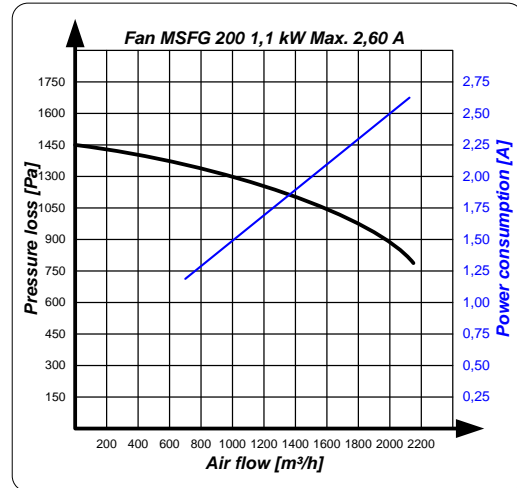



GEOVENT

FAN

LSFG/MSFG 146 to 250 – and LSX/MSX ATEX versions

Dimensions

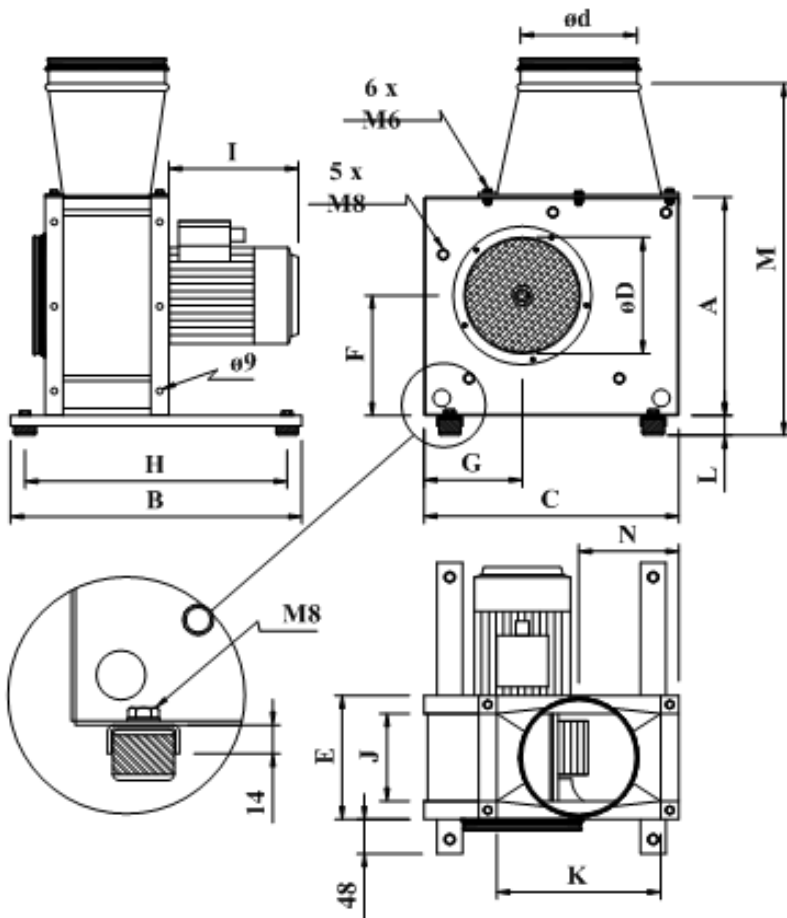

Dimension table Fans LSFG/MSFG 146-250

Type	A	B	C	D	E	F	G	H	I	J	K	L	M	N	Weight
146	245	400	295	160	145	134	113	360	178	95	185	27	402	118	12 kg
180	300	400	350	160	168	165	135	360	178	120	225	27	527	138	14 kg
200	350	400	400	200	180	205	165	360	205	130	250	27	577	150	18 kg
225	370	500	450	250	195	210	190	460	219	145	280	27	597	165	24 kg
250	410	500	500	250	215	230	210	460	300	170	320	27	637	185	28 kg

NB: By LSX/MSX versions the motor will typically have a larger physical measure than standard versions, and therefore it will also have a higher net weight.



Sound data – measured in inlet

Type	125 Hz	250 Hz	500 Hz	1000 Hz	2000 Hz	4000 Hz	8000 Hz	Lp, dB(A)	Lp, 1m
LSFG 146	46	47	48	46	45	41	35	51	45
LSFG 180	54	57	53	50	47	42	36	56	50
LSFG 200	61	62	58	57	50	45	40	61	55
LSFG 225	62	63	59	58	54	51	45	63	57
LSFG 250	66	67	64	63	60	54	46	67	61
MSFG 146	61	62	65	63	64	58	51	69	63
MSFG 180	70	80	69	64	65	59	54	74	68
MSFG 200	80	83	72	71	71	66	61	78	72
MSFG 225	82	85	75	73	74	68	63	81	75
MSFG 250	86	90	77	75	76	71	65	84	78

Accessories

Soundproof box for reduction of the sound level.
The fan is enclosed in a closed wind- and waterproof galvanized box.
The sound is typically subdued to 8-15 dB(A)

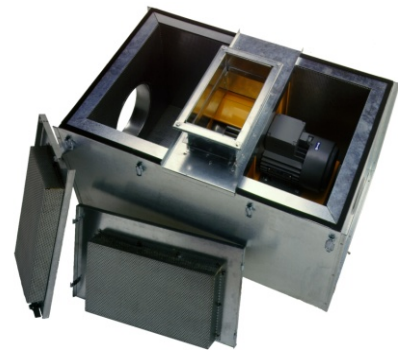

Wall bracket, hot-galvanized, is supplied in two sizes,
For mounting the fan on wall
Must be used with supporting brackets.



Galvanized rain shield for the fan.
Protects the motor from water intrusion



Outlet flange, hot-galvanized, is supplied in several
Different sizes. Is used as transition from the fan's square outlet
to a circular channel.



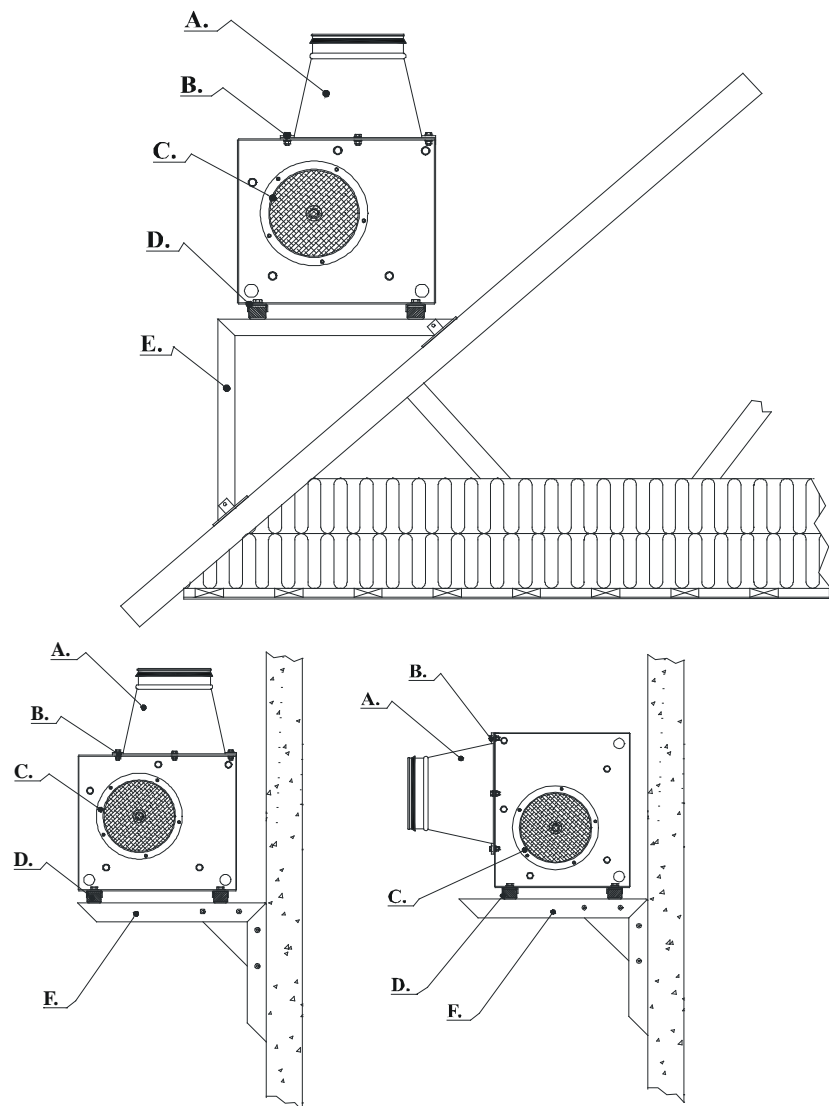

- A. Outlet flange, transition from the fan's square yield to a round channel. The outlet flange, which is a sleeve, has an EPDM rubber packing in sealing class C. By using vibration dampers a flexible connection between the outlet flange and the yield can be inserted. .
- B. Clamp, galvanized, is used for attachment of the outlet flange with the aid of 6 pcs. M6 screws. After mounting you must use joint filler.
- C. Inlet in sleeve, galvanized, is provided with net to protect the fans impeller and EPDM rubber packing in sealing class c. By using vibration dampers a flexible connection between the inlet and the piping can be inserted.
- D. Supporting angels, galvanized, is supplied with or without vibration dampers depending on the application. The vibration dampers are adjusted to each Fan.
- E. Roof bracket GB 15-45°, galvanized, is supplied with angel brackets on 200x1.000mm, so it is possible to saw off until you have the right pitch. The roof bracket is supplied with 4 pcs. Of mounting sheets with holes for the most common roofing tiles.
- F. Wall bracket, galvanized, is supplied as a complete set with screws for mounting the fan.



Ordering table – LSFG/MSFG 146 - 250				
Art. No.	Model	(kW)	(Volt)	(Ampere)
38-001	LSFG 146-3	0,25	3x400	0,81
38-002	MSFG 146-3	0,55	3x400	1,30
38-003	GLSFG 146-3	0,25	3x400	0,81
38-004	GMSFG 146-3	0,55	3x400	1,30
38-005	LSFG 146-1	0,25	1x230	1,40
38-006	MSFG 146-1	0,55	1x230	3,4
30-001	LSFG 180-3	0,25	3x400	0,81
30-002	MSFG 180-3	0,55	3x400	1,30
30-003	GLSFG 180-3	0,25	4x400	0,81
30-004	GMSFG 180-3	0,55	3x400	1,30
30-005	LSFG 180-1	0,25	1x230	3,40
30-006	MSFG 180-1	0,55	1x230	2,25
31-001	LSFG 200-3	0,55	3x400	1,3
31-002	MSFG 200-3	1,10	3x400	2,6
31-003	GLSFG 200-3	0,55	3x400	1,3
31-004	GMSFG 200-3	1,10	3x400	2,20
31-005	LSFG 200-1	0,55	1x230	1,61
31-006	MSFG 200-1	1,10	1x230	3,4
32-001	LSFG 225-3	1,10	3x400	3,6
32-002	MSFG 225-3	2,20	3x400	4,70
32-003	GLSFG 225-3	1,00	3x400	3,0
32-004	GMSFG 225-3	2,20	3x400	3,82
32-005	LSFG 225-1	1,10	1x230	6,24
32-006	MSFG 225-1	2,20	1x230	13,4
33-001	LSFG 250-3	2,20	3x400	5,1
33-002	MSFG 250-3	4,90	3x400	8,8
33-003	GLSFG 250-3	2,20	3x400	5,1
33-004	GMSFG 250-3	3,00	3x400	6,2



ATEX Fan LSX/MSX

Our series of atex fans with forward curving impeller are as standard supplied with EEx e motors, but can also be supplied with EEx d or EEx de motors.

The typical scope of application is zone 1, zone 2 and zone 22.

The construction is based on standard LSF/MSFG, but has beside the ATEX motor, also protection against static and sparks in inlet.

For ATEX applications, where acid proof execution is needed, this can be offered. All plate parts, screws and bolts a.s.o. are supplied in rustproof ANSI 316L and are subsequently stained. The impeller is either supplied in a special lacquered edition or in ANSI 316L.

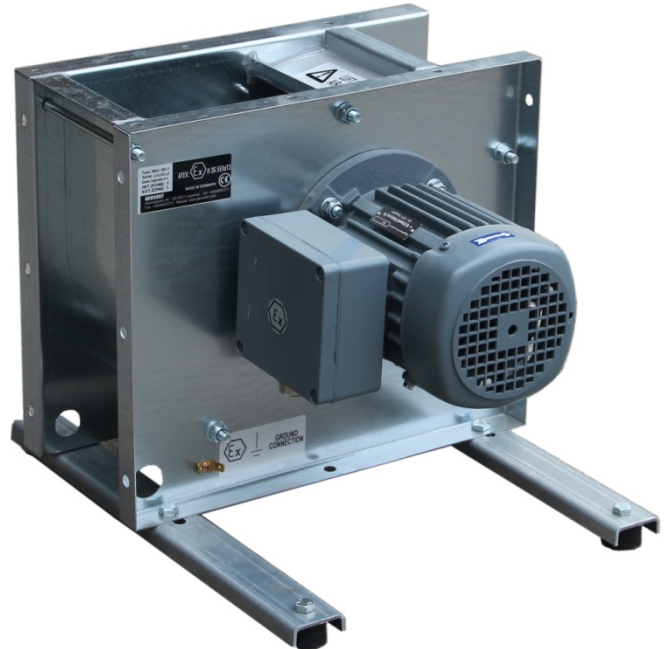

Ordering table – LSX/MSX 146 - 250				
Art. No.	Model	(kW)	(Volt)	(Ampere)
37-010	LSX 146-3	0,25	3x400	0,81
37-020	MSX 146-3	0,55	3x400	1,30
37-030	LSX 180-3	0,25	3x400	0,93
37-040	MSX 180-3	0,55	3x400	1,30
37-050	LSX 200-3	0,55	3x400	2,20
37-060	MSX 200-3	1,1	3x400	2,60
37-070	LSX 225-3	1,00	3x400	3,00
37-080	MSX 225-3	1,85	3x400	3,82
37-090	LSX 250-3	2,00	3x400	5,10
37-100	MSX 250-3	3,30	3x400	6,20

