

ABB general machinery drives

ACS350, 0.37 to 11 kW / 0.5 to 15 hp

Technical catalogue





Two ways to select your drive

Choice 1: Simply contact your local ABB drives sales office (see page 15) and let them know what you want. Use page 3 as a reference section for more information.

OR

Choice 2: Build up your own ordering code using the simple 7-step approach below. Each step is accompanied by a reference to a page that is filled with useful information.

Type code structure:

ACS350 - 01E - 02A4 - 2 + J400

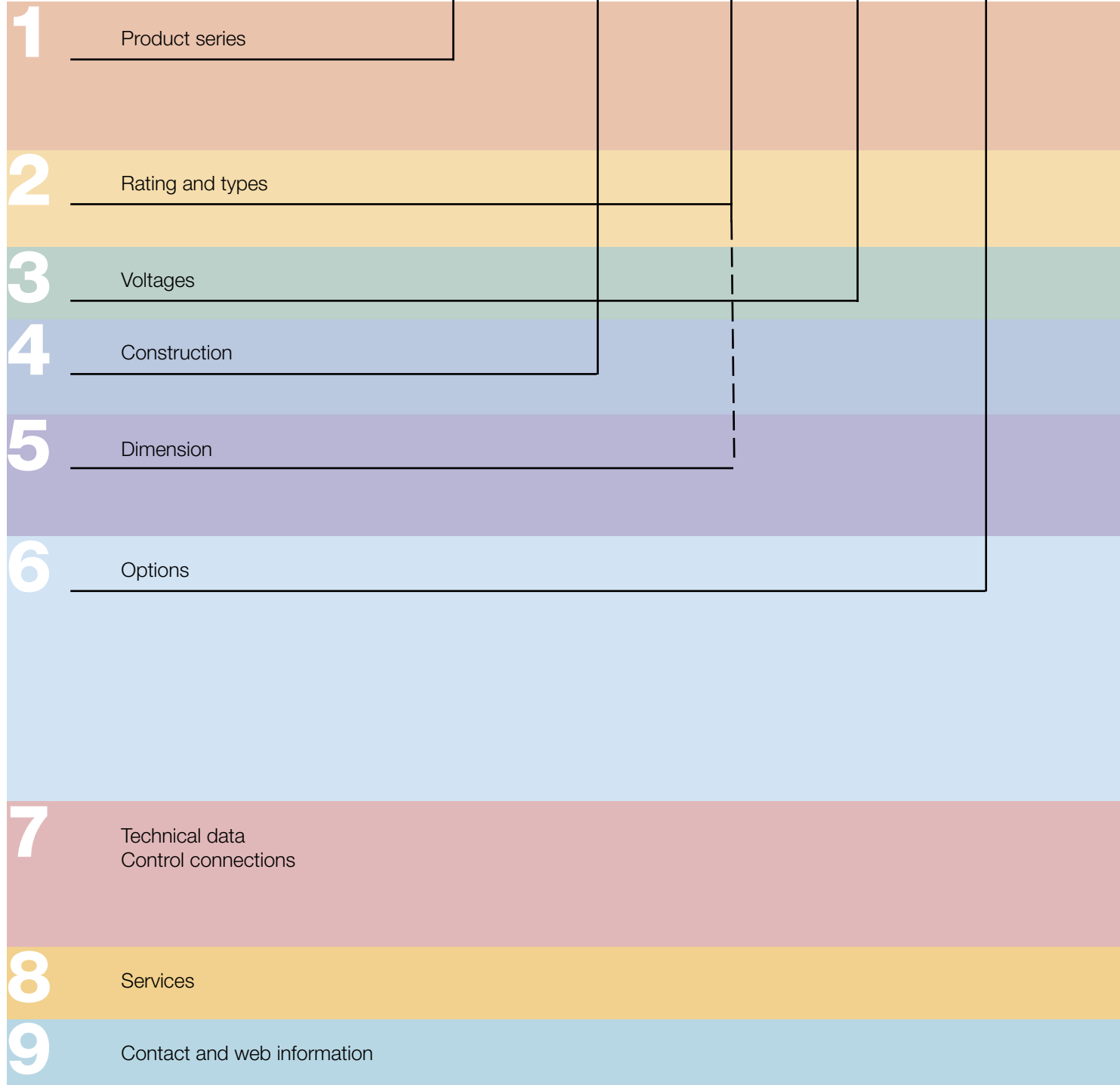

Contents



ABB general machinery drives, ACS350

ABB general machinery drives4	1
Features4	
Technical specification5	
Electromagnetic compatibility6	
Ratings, types, voltages and construction6	2
Type code6	
Voltages6	3
Construction6	4
Phase and EMC filtering6	
Dimensions7	5
Cabinet-mounted drives7	
Wall-mounted drives7	
Options7	6
How to select options7	
User interfaces8	
Machine interfaces9	
Protection and installation9	
FlashDrop10	
Brake resistors10	
Input and output chokes10	
DriveWindow Light 211	
Technical data12	7
Cooling and fuses12	
Control connections13	
Connection examples13	
Services14	8
www.abb.com/motors&drives15	9

ABB general machinery drives



ACS350 - 01E - 02A4 - 2 + J400

ABB general machinery drives

ABB general machinery drives are designed for machine building. In serial type manufacturing the consumed time per unit is critical. The drives are designed to be the fastest drives in terms of installation, setting parameters and commissioning. The basic products have been made as user-friendly as possible, yet providing high intelligence. The drives offer diverse functionality to cater for the most demanding needs.

Applications

ABB general machinery drives are designed to meet the requirements of an extensive range of machinery applications. The drives are ideal for food and beverage, material handling, textile, printing, rubber and plastics, and woodworking applications.

Highlights

- FlashDrop
- Sequence programming
- Impressive software and compact hardware
- Optimized interfaces for users and machines
- Unified height and depth
- Convenient installation

Features	Benefits	Notes
FlashDrop	Faster and easier drive set up and commissioning for volume manufacturing.	New fast, safe and trouble-free parametrization method without electricity. Patented.
Sequence programming	Logic programming included as standard. Reduces the need for external PLC.	Application specific 8-state programming with comprehensive transition and triggering conditions.
Software	High technology and performance with exceptional flexibility.	Sensorless vector control with a set of innovative features.
User interfaces	Cost efficient approach without control panels. Different control panels available according to functionality need.	Panel cover for protection as standard. Assistant control panel with clear alphanumerical dynamic menus, real time clock and 14 languages. Basic panel with numerical display.
Fieldbuses	High speed communication with compact and robust fieldbus design.	Enclosed plug-in type of fieldbus adapters.
Cabinet compatibility	Optimum installation layout and efficient cabinet space usage.	Screw, DIN-rail, sideways and side-by-side mounting. Unified height and depth.
Inbuilt EMC filter	No extra space, parts, time or cost required.	2 nd environment filter complying with IEC 61800-3 as standard.
Inbuilt brake chopper	Reduced cost, saved space and simple wiring.	100% braking capability.
Drive protection	Latest solutions to protect the drive and offer trouble free use and the highest quality.	Motor output and IO protected against miswiring. Protection against unstable supply networks. Coated boards included as standard.

Technical specification



ACS350 - 01E - 02A4 - 2 + J400

Mains connection

Voltage and power range	1-phase, 200 to 240 V $\pm 10\%$ 0.37 to 2.2 kW (0.5 to 3 hp) 3-phase, 200 to 240 V $\pm 10\%$ 0.37 to 4 kW (0.5 to 5 hp) 3-phase, 380 to 480 V $\pm 10\%$ 0.37 to 11 kW (0.5 to 15 hp)
Frequency	48 to 63 Hz
Power factor	0.98

Motor connection

Voltage	3-phase, from 0 to U_{SUPPLY}
Frequency	0 to 500 Hz
Continuous loading capability <small>(constant torque at a max. ambient temperature of 40°C)</small>	Rated output current I_{2N}
Overload capacity <small>(at a max. ambient temperature of 40°C)</small>	At heavy duty use $1.5 \times I_{2N}$ for 1 minute every 10 minutes At start $1.8 \times I_{2N}$ for 2 s
Switching frequency	
Default	4 kHz
Selectable	4 to 16 kHz with 4 kHz steps
Acceleration time	0.1 to 1800 s
Deceleration time	0.1 to 1800 s
Braking	Inbuilt brake chopper as standard
Speed control	
Static accuracy	20% of motor nominal slip
Dynamic accuracy	< 1% s with 100% torque step
Torque control	
Torque step rise time	< 10ms with nominal torque
Non-linearity	$\pm 5\%$ with nominal torque

Environmental limits

Ambient temperature	-10 to 40°C (14 to 104°F), no frost allowed 50°C (122°F) with 10% derating
Altitude	
Output current	Rated current available at 0 to 1000 m (0 to 3281 ft) reduced by 1% per 100 m (328 ft) over 1000 to 2000 m (3281 to 6562 ft)
Relative humidity	Lower than 95% (without condensation)
Degree of protection	IP20 / optional NEMA 1 enclosure
Enclosure colour	NCS 1502-Y, RAL 9002, PMS 420 C
Contamination levels	IEC721-3-3
Transportation	No conductive dust allowed Class 1C2 (chemical gases) Class 1S2 (solid particles)
Storage	Class 2C2 (chemical gases) Class 2S2 (solid particles)
Operation	Class 3C2 (chemical gases) Class 3S2 (solid particles)

Product compliance

Low Voltage Directive 73/23/EEC with supplements
Machinery Directive 98/37/EC
EMC Directive 89/336/EEC with supplements
Quality assurance system ISO 9001
Environmental system ISO 14001
UL, cUL, CE, C-Tick and GOST R approvals

Programmable control connections

Two analog inputs	
Voltage signal	
Unipolar	0 (2) to 10 V, $R_{in} > 312 \text{ k}\Omega$
Bipolar	-10 to 10 V, $R_{in} > 312 \text{ k}\Omega$
Current signal	
Unipolar	0 (4) to 20 mA, $R_{in} = 100 \Omega$
Bipolar	-20 to 20 mA, $R_{in} = 100 \Omega$
Potentiometer reference value	10 V $\pm 1\%$ max. 10 mA, $R < 10 \text{ k}\Omega$
Resolution	0.1%
Accuracy	$\pm 1\%$
One analog output	0 (4) to 20 mA, load < 500 Ω
Auxiliary voltage	24 V DC $\pm 10\%$, max. 200 mA
Five digital inputs	12 to 24 V DC with internal or external supply, PNP and NPN, pulse train 0 to 10 kHz
Input impedance	2.4 k Ω
One relay output	
Type	NO + NC
Maximum switching voltage	250 V AC/30 V DC
Maximum switching current	0.5 A/30 V DC; 5 A/230 V AC
Maximum continuous current	2 A rms
One digital output	
Type	Transistor output
Maximum switching voltage	30 V DC
Maximum switching current	100 mA/30 V DC, short circuit protected
Frequency	10 Hz to 16 kHz
Resolution	1 Hz
Accuracy	0.2%

Serial communication

Fieldbuses	Plug-in type
Refresh rate	< 10 ms (between drive and fieldbus module)
PROFIBUS DP	9-pin D-connector Baud rate up to 12 Mbit/s PROFIBUS DP and PROFIBUS DPV1 Network side based on "PROFIdrive" profile.
DeviceNet	5-pin screw type connector Baud rate up to 500 kbit/s Network side based on ODVA "AC/DC drive" profile.
CANopen	9-pin D-connector Baud rate up to 1 Mbit/s Network side based on CiA DS402 profile.
Modbus	4-pin screw type connector Baud rate up to 115 kbit/s

Chokes

AC input chokes	External option For reducing THD in partial loads and to comply with EN61000-3-2.
AC output chokes	External option To achieve longer motor cables

Electromagnetic compatibility



ACS350 - 01E - 02A4 - 2 + J400

EMC according to EN61800-3

2nd environment filter, unrestricted distribution, C3 with 30 m (98 ft) cable, inbuilt as standard.

EMC standards in general

EN 61800-3/A11 (2000), product standard	EN 61800-3 (2004), product standard	EN 55011, product family standard for industrial, scientific and medical (ISM) equipment
1 st environment, unrestricted distribution	Category C1	Group 1 Class B
1 st environment, restricted distribution	Category C2	Group 1 Class A
2 nd environment, unrestricted distribution	Category C3	Group 2 Class A
2 nd environment, restricted distribution	Category C4	Not applicable

Ratings, types, voltages and construction

ACS350 - 01E - 02A4 - 2 + J400

Type code

This is the unique reference number (shown above and in column 4, right) that clearly identifies your drive by power rating and frame size. Once you have selected the type code, the frame size (column 5) can be used to determine the drive dimensions, shown on the next page.

Voltages

ACS350 is available in two voltage ranges:

2 = 200 - 240 V

4 = 380 - 480 V

Insert either "2" or "4", depending on your chosen voltage, into the type code shown above.

Construction

"01E" within the type code (shown above) varies depending on the drive phase and EMC filtering. Choose below the one you need.

01 = 1-phase

03 = 3-phase

E = EMC filter connected, 50 Hz frequency

U = EMC filter disconnected, 60 Hz frequency

(In case the filter is required it can easily be connected.)

Ratings			Type code	Frame size
P _N kW	P _N hp	I _{2N} A		
1-phase supply voltage 200 - 240 V units				
0.37	0.5	2.4	ACS350-01X-02A4-2	R0
0.75	1	4.7	ACS350-01X-04A7-2	R1
1.1	1.5	6.7	ACS350-01X-06A7-2	R1
1.5	2	7.5	ACS350-01X-07A5-2	R2
2.2	3	9.8	ACS350-01X-09A8-2	R2
3-phase supply voltage 200 - 240 V units				
0.37	0.5	2.4	ACS350-03X-02A4-2	R0
0.55	0.75	3.5	ACS350-03X-03A5-2	R0
0.75	1	4.7	ACS350-03X-04A7-2	R1
1.1	1.5	6.7	ACS350-03X-06A7-2	R1
1.5	2	7.5	ACS350-03X-07A5-2	R1
2.2	3	9.8	ACS350-03X-09A8-2	R2
3	4	13.3	ACS350-03X-13A3-2	R2
4	5	17.6	ACS350-03X-17A6-2	R2
3-phase supply voltage 380 - 480 V units				
0.37	0.5	1.2	ACS350-03X-01A2-4	R0
0.55	0.75	1.9	ACS350-03X-01A9-4	R0
0.75	1	2.4	ACS350-03X-02A4-4	R1
1.1	1.5	3.3	ACS350-03X-03A3-4	R1
1.5	2	4.1	ACS350-03X-04A1-4	R1
2.2	3	5.6	ACS350-03X-05A6-4	R1
3	4	7.3	ACS350-03X-07A3-4	R1
4	5	8.8	ACS350-03X-08A8-4	R1
5.5	7.5	12.5	ACS350-03X-12A5-4	R3
7.5	10	15.6	ACS350-03X-15A6-4	R3
11	15	23.1	ACS350-03X-23A1-4	R3

X within the type code stands for E or U.

Dimensions



ACS350 - 01E - 02A4 - 2 + J400

Cabinet-mounted drives (IP20 UL open)

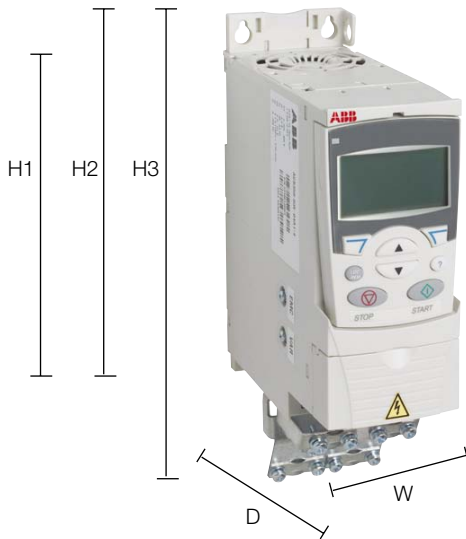

Wall-mounted drives (NEMA 1)

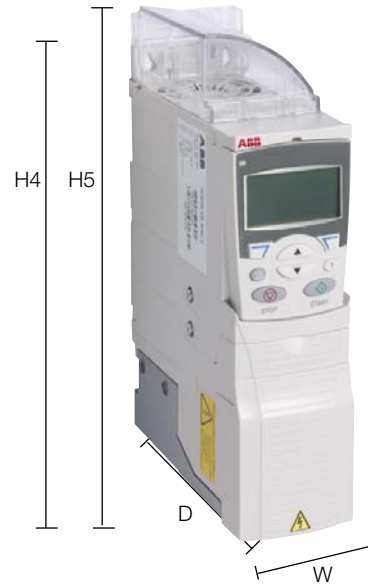

Frame size	IP20 UL open						NEMA 1				
	H1 mm	H2 mm	H3 mm	W mm	D mm	Weight kg	H4 mm	H5 mm	W mm	D mm	Weight kg
R0	169	202	239	70	161	1.1	257	280	70	169	1.5
R1	169	202	239	70	161	1.3	257	280	70	169	1.7
R2	169	202	239	105	165	1.5	257	282	105	169	1.9
R3	169	202	236	169	169	2.5	260	299	169	177	3.1

H1 = Height without fastenings and clamping plate
 H2 = Height with fastenings but without clamping plate
 H3 = Height with fastenings and clamping plate
 H4 = Height with fastenings and NEMA 1 connection box
 H5 = Height with fastenings, NEMA 1 connection box and hood
 W = Width
 D = Depth

Options

ACS350 - 01E - 02A4 - 2 + J400

How to select options

The options shown in the table are available within the ACS350 range. Each has an associated 4-figure option code, which is shown in the first column. It is this code that replaces J400 in the type code above. You can order as many options as required, simply by extending the code as necessary.

Selection table

Protection class		
- 1)	NEMA 1 (R0, R1, R2)	MUL1-R1
- 1)	NEMA 1 (R3)	MUL1-R3
Control panel		
J400	Assistant control panel	ACS-CP-A
J404	Basic control panel	ACS-CP-C
- 1)	Panel mounting kit	ACS/H-CP-EXT
Potentiometer		
J402	Potentiometer	MPOT-01
Fieldbus		
K451	DeviceNet	FDNA-01
K454	PROFIBUS DP	FPBA-01
K457	CANopen	FCAN-01
K458	ModBus RTU	FMBA-01
External options		
- 1)	FlashDrop	MFDT-01
- 1)	DriveWindow Light 2	DriveWindow Light 2

1) Ordering with a separate MRP code number.



Options Interfaces

ACS350 - 01E - 02A4 - 2 + J400

User interfaces

Panel cover

The purpose of the panel cover is to protect the drive's connection surfaces. The ACS350 drive is delivered with a panel cover as standard. In addition there are two alternative control panels available as options.

Basic control panel

The basic control panel features a single line numeric display. The panel can be used to control the drive, set the parameter values or copy them from one drive to another.

Assistant control panel

The assistant control panel features a multilingual alphanumeric display for easy drive programming. The control panel has various assistants and an inbuilt help function to guide the user. It includes a real time clock, which can be used during fault logging and in controlling the drive, such as start/stop. The control panel can be used for copying parameters for back up or for downloading to another drive. A large graphical display and soft keys make it extremely easy to navigate.

Potentiometer

Potentiometer MPOT-01 with two switches: start/stop and forward/reverse. Polarity is selected with DIP switches. No external power source is needed for the potentiometer.

Panel mounting kit

The panel mounting kit enables mounting of control panels on cabinet doors. This kit includes a 3 m extension cable, a gasket, mounting screws and a mounting template.



Panel cover
(included as standard)



Basic control panel



Potentiometer



Assistant control panel

Options Interfaces



ACS350 - 01E - 02A4 - 2 + J400



Machine interfaces

The plug-in fieldbus modules bring connectivity to major automation systems. A single twisted pair avoids large amounts of conventional cabling, thereby reducing costs and increasing system reliability.

ACS350 supports the following fieldbus options:

- DeviceNet
- PROFIBUS DP
- CANopen
- Modbus RTU

Protection and installation

NEMA 1 kit

The NEMA 1 kit includes a connection box for finger protection, conduit tube installation, and a hood for protection against dirt and dust.

Terminal cover

The terminal cover is for protection of the I/O connections.

Clamping plates

The clamping plates are used for protection against electrical disturbances. The clamping plates with the clamps are included in the drive package as standard.

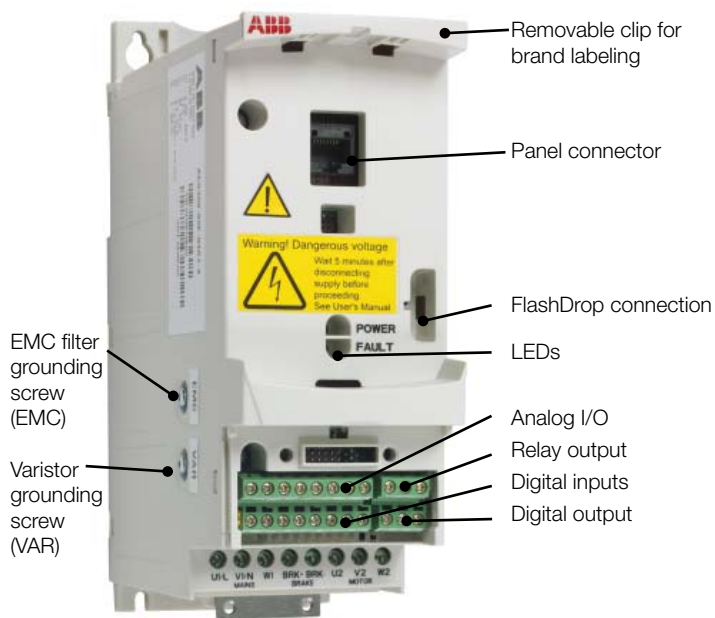

Terminal cover
(included as standard)

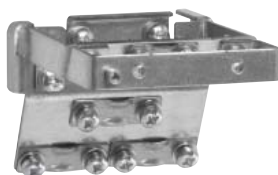

Clamping plates
(included as standard)



Options

External

A separate order line and type code is required for any of these external options.

FlashDrop

FlashDrop is a powerful palm sized tool for fast and easy parameter selecting and setting. It gives the possibility to hide selected parameters to protect the machine. Only the parameters needed in the application are shown. The tool can copy parameters between two drives or between a PC and a drive. All the above can be done without a power connection to the drive – in fact, it is not even necessary to unpack the drive.

DrivePM

DrivePM (Drive parameter manager) is a tool to create, edit and copy parameter sets for FlashDrop. For each parameter/group the user has a possibility to hide it, which means that the drive user does not see the parameter/group at all.

DrivePM requirements

- Windows 2000/XP
- Free serial port from a PC

FlashDrop tool includes

- FlashDrop
- DrivePM software on a CD-rom
- User's manual in pdf-format on the CD-rom
- Cable OPCA-02 for connection between the PC and FlashDrop
- Battery charger



Brake resistors

The brake resistor is selected using the table below. For more information about the selection of brake resistors, see the ACS350 User's Manual.

ACS350 is delivered with an integrated brake chopper as standard. Therefore no additional space or installation time is needed.

Selection table

Type code	Frame size	R _{min} ohm	R _{max} ohm	P _{BRmax}	
				kW	hp
1-phase supply voltage 200 - 240 V units					
ACS350-01X-02A4-2	R0	70	390	0.37	0.5
ACS350-01X-04A7-2	R1	40	200	0.75	1
ACS350-01X-06A7-2	R1	40	130	1.1	1.5
ACS350-01X-07A5-2	R2	30	100	1.5	2
ACS350-01X-09A8-2	R2	30	70	2.2	3
3-phase supply voltage 200 - 240 V units					
ACS350-03X-02A4-2	R0	70	390	0.37	0.5
ACS350-03X-03A5-2	R0	70	260	0.55	0.75
ACS350-03X-04A7-2	R1	40	200	0.75	1
ACS350-03X-06A7-2	R1	40	130	1.1	1.5
ACS350-03X-07A5-2	R1	30	100	1.5	2
ACS350-03X-09A8-2	R2	30	70	2.2	3
ACS350-03X-13A3-2	R2	30	50	3	4
ACS350-03X-17A6-2	R2	30	40	4	5
3-phase supply voltage 380 - 480 V units					
ACS350-03X-01A2-4	R0	200	1180	0.37	0.5
ACS350-03X-01A9-4	R0	175	800	0.55	0.75
ACS350-03X-02A4-4	R1	165	590	0.75	1
ACS350-03X-03A3-4	R1	150	400	1.1	1.5
ACS350-03X-04A1-4	R1	130	300	1.5	2
ACS350-03X-05A6-4	R1	100	200	2.2	3
ACS350-03X-07A3-4	R1	70	150	3	4
ACS350-03X-08A8-4	R1	70	110	4	5
ACS350-03X-12A5-4	R3	40	80	5.5	7.5
ACS350-03X-15A6-4	R3	40	60	7.5	10
ACS350-03X-23A1-4	R3	30	40	11	15

X within the type code stands for E or U.

Input and output chokes

For input and output chokes, please contact your nearest ABB drives channel partner or local ABB office.



Options

Software tools

A separate order line and type code is required for any of these software tool options.

DriveWindow Light 2

DriveWindow Light 2 is an easy-to-use start-up and maintenance tool for ACS350 drives. It can be used in an offline mode, which enables parameter setting at the office even before going to the actual site. The parameter browser enables viewing, editing and saving of parameters. The parameter comparison feature makes it possible to compare parameter values between the drive and the file. With the parameter subset you can create your own parameter sets. Controlling of the drive is naturally one of the features in DriveWindow Light. With this software tool, you can monitor up to four signals simultaneously. This can be done in both graphical and numerical format. Any signal can be set to stop the monitoring from a predefined level.

Sequence programming tool

For ACS350, DriveWindow Light 2 offers sequence programming, which is a tool for setting up the sequence programming parameters. The tool draws the program graphically on the PC screen showing used states, active state, transition conditions, possible transition delay as well as used reference and ramp.

Sequence programming enables application specific programming. This new and easy way to preset sequences reduces the need for an external programmable logic control (PLC). In simple applications an external PLC can be left out.

Start-up wizards

Start-up wizards make the setting of parameters easy. Simply launch the wizard, select an appropriate assistant e.g. for setting analog outputs, and all parameters related to this function are shown together with help pictures.

Highlights

- Sequence programming tool for ACS350
- Editing, saving and downloading parameters
- Graphical and numerical signal monitoring
- Drive control
- Start-up wizards

DriveWindow Light requirements

- Windows NT/2000/XP
- Free serial port from a PC
- Free control panel connector

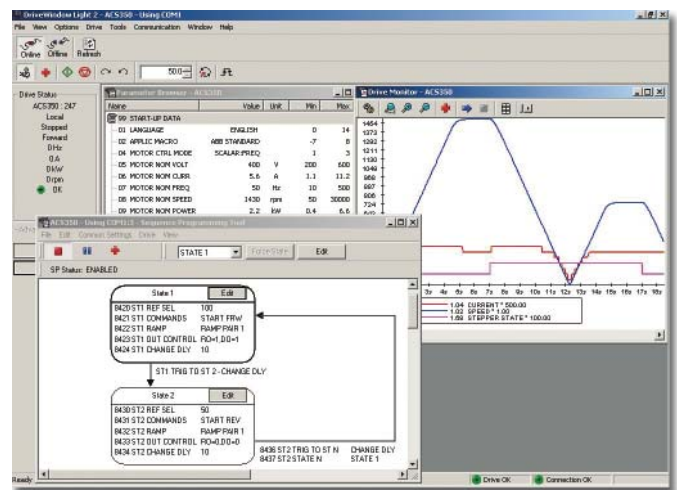



Cooling

ACS350 is fitted with cooling fans as standard. The cooling air must be free from corrosive substances and must not be above the maximum ambient temperature of 40°C (50°C with derating). For more specific limits see the Technical specification - Environmental limits in this catalogue.

Cooling air flow

Type code	Frame size	Heat dissipation		Air flow	
		w	BTU/Hr	m ³ /h	ft ³ /min
1-phase supply voltage 200 - 240 V units					
ACS350-01X-02A4-2	R0	25	85	-*)	-*)
ACS350-01X-04A7-2	R1	46	157	24	14
ACS350-01X-06A7-2	R1	71	242	24	14
ACS350-01X-07A5-2	R2	73	249	21	12
ACS350-01X-09A8-2	R2	96	328	21	12
3-phase supply voltage 200 - 240 V units					
ACS350-03X-02A4-2	R0	19	65	-*)	-*)
ACS350-03X-03A5-2	R0	31	106	-*)	-*)
ACS350-03X-04A7-2	R1	38	130	24	14
ACS350-03X-06A7-2	R1	60	205	24	14
ACS350-03X-07A5-2	R1	62	212	21	12
ACS350-03X-09A8-2	R2	83	283	21	12
ACS350-03X-13A3-2	R2	112	383	52	31
ACS350-03X-17A6-2	R2	152	519	52	31
3-phase supply voltage 380 - 480 V units					
ACS350-03X-01A2-4	R0	11	38	-*)	-*)
ACS350-03X-01A9-4	R0	16	55	-*)	-*)
ACS350-03X-02A4-4	R1	21	72	13	8
ACS350-03X-03A3-4	R1	31	106	13	8
ACS350-03X-04A1-4	R1	40	137	13	8
ACS350-03X-05A6-4	R1	61	208	19	11
ACS350-03X-07A3-4	R1	74	253	24	14
ACS350-03X-08A8-4	R1	94	321	24	14
ACS350-03X-12A5-4	R3	130	444	52	31
ACS350-03X-15A6-4	R3	173	591	52	31
ACS350-03X-23A1-4	R3	266	908	71	42

X within the type code stands for E or U.

*) Frame size R0 with free convection cooling.

Free space requirements

Enclosure type	Space above mm	Space below mm	Space on left/right mm
All frame sizes	75	75	0

Fuses

Standard fuses can be used with ABB general machinery drives. For input fuse connections see table below.

Selection table

Type code	Frame size	IEC Fuses		UL Fuses	
		A	Fuse type ^{*)}	A	Fuse type ^{*)}
1-phase supply voltage 200 - 240 V units					
ACS350-01X-02A4-2	R0	10	gG	10	UL class T
ACS350-01X-04A7-2	R1	16	gG	20	UL class T
ACS350-01X-06A7-2	R1	20	gG	25	UL class T
ACS350-01X-07A5-2	R2	25	gG	30	UL class T
ACS350-01X-09A8-2	R2	35	gG	35	UL class T
3-phase supply voltage 200 - 240 V units					
ACS350-03X-02A4-2	R0	10	gG	10	UL class T
ACS350-03X-03A5-2	R0	10	gG	10	UL class T
ACS350-03X-04A7-2	R1	10	gG	15	UL class T
ACS350-03X-06A7-2	R1	16	gG	15	UL class T
ACS350-03X-07A5-2	R1	16	gG	15	UL class T
ACS350-03X-09A8-2	R2	16	gG	20	UL class T
ACS350-03X-13A3-2	R2	25	gG	30	UL class T
ACS350-03X-17A6-2	R2	25	gG	35	UL class T
3-phase supply voltage 380 - 480 V units					
ACS350-03X-01A2-4	R0	10	gG	10	UL class T
ACS350-03X-01A9-4	R0	10	gG	10	UL class T
ACS350-03X-02A4-4	R1	10	gG	10	UL class T
ACS350-03X-03A3-4	R1	10	gG	10	UL class T
ACS350-03X-04A1-4	R1	16	gG	15	UL class T
ACS350-03X-05A6-4	R1	16	gG	15	UL class T
ACS350-03X-07A3-4	R1	16	gG	20	UL class T
ACS350-03X-08A8-4	R1	20	gG	25	UL class T
ACS350-03X-12A5-4	R3	25	gG	30	UL class T
ACS350-03X-15A6-4	R3	35	gG	35	UL class T
ACS350-03X-23A1-4	R3	50	gG	50	UL class T

X within the type code stands for E or U.

*) According to IEC-60269 standard.



Control connections

These connections are shown as examples only. Please refer to the ACS350 User's Manual for more detailed information.

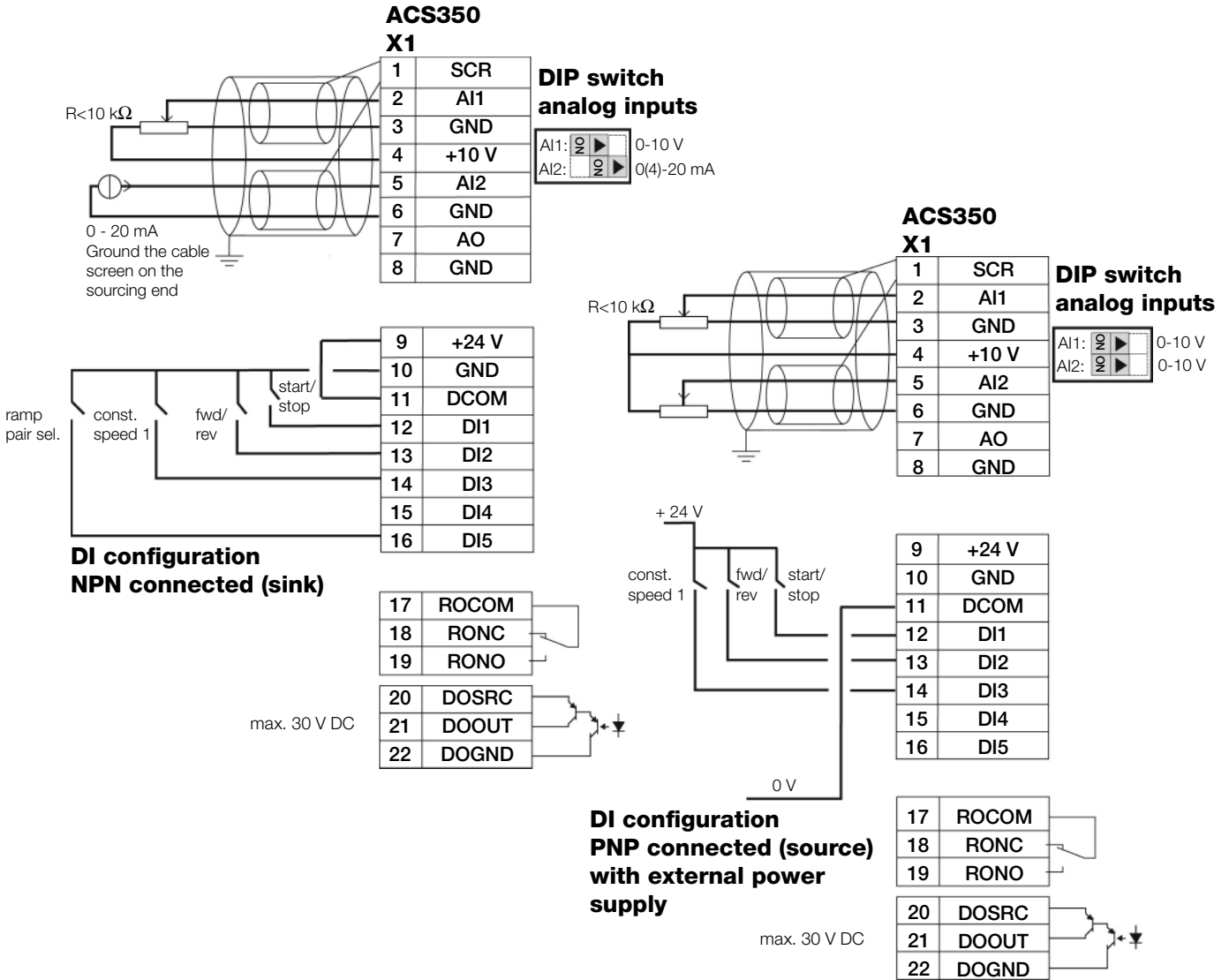

Analogue input can also be used with bipolar voltages:

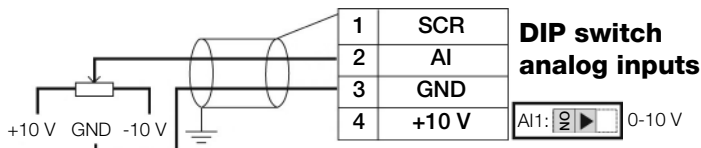



All the support you need

The ABB drive product lifecycle management model provides proactive service offerings for maximizing drive availability and performance. This four-phase model provides not only optimum support to you but also a smooth transition to a new drive when the service life of your current drive ends. It also provides ABB with a well-structured means of managing different drive generations. With complete lifecycle support, you will always be aware of the support plans for your valuable assets.

Globally local

ABB has the largest drive service team of all drive suppliers with field service engineers located throughout the world. In addition, the ABB drives channel partners - the technical partner network with outlets in many countries – provide you with round-the-clock support and service. All ABB's and its channel partners' drive specialists have been trained,

audited and certified to exacting standards allowing each to provide fast and professional support where and when you need it.

Training services

ABB offers dedicated training on ACS350 drives for your service and operating personnel for acquiring the required skills to use ABB drives correctly and safely and to run the application in the most effective way.

Selection table

Service product code	Service type	Description
G350E	ACS350 fundamentals	Internet course
G350	ACS350 operation & programming	Hands-on course

More details and specific information about our support, service and training offerings is available in product specific brochures, from local ABB representatives and on the ABB internet pages www.abb.com/motors&drives and www.abb.com/abbuniversity.

Drives product lifecycle management

Product lifecycle phases:



ABB is following a four-phase model for managing lifecycles of its drives for enhanced customer support and improved efficiency. Many ABB products have been and will be supported.

Contact and web information

www.abb.com/motors&drives

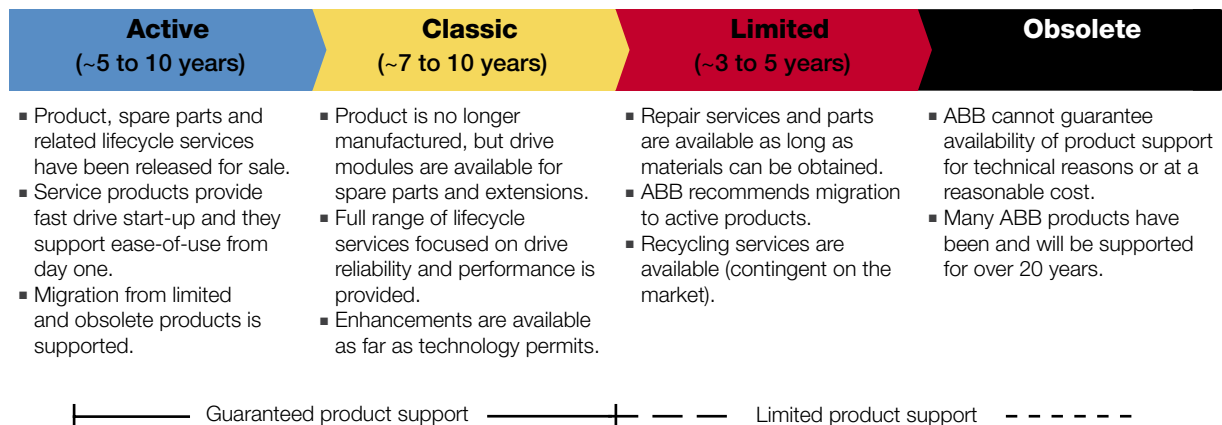

ABB's worldwide presence is built on strong local companies working together with the channel partner network. By combining the experience and know-how gained in local and global markets, ABB ensures that its customers in all industries gain the full benefit from its products.

For further details about all ABB low voltage AC drives and services, please contact your nearest ABB office or ABB drives channel partner or visit the websites www.abb.com/motors&drives and www.abb.com/drivespartners.

Albania (Tirana)

Tel: +355 4 234 368, 363 854
Fax: +355 4 363 854

Algeria

Tel: +212 2224 6168
Fax: +212 2224 6171

Argentina (Valentin Alsina)

Tel: +54 (0)114 229 5707
Fax: +54 (0)114 229 5593

Australia (Victoria - Notting Hill)

Tel: +1800 222 435
Tel: +61 3 8544 0000
email: drives@au.abb.com

Austria (Vienna)

Tel: +43 1 60109 0
Fax: +43 1 60109 8312

Azerbaijan (Baku)

Tel: +994 12 598 54 75
Fax: +994 12 493 73 56

Bahrain (Manama)

Tel: +973 725 377
Fax: +973 725 332

Bangladesh (Dhaka)

Tel: +88 02 8856468
Fax: +88 02 8850906

Belarus (Minsk)

Tel: +375 228 12 40, 228 12 42
Fax: +375 228 12 43

Belgium (Zaventem)

Tel: +32 2 718 6320
Fax: +32 2 718 6664

Bolivia (La Paz)

Tel: +591 2 278 8181
Fax: +591 2 278 8184

Bosnia Herzegovina (Tuzla)

Tel: +387 35 246 020
Fax: +387 35 255 098

Brazil (Osasco)

Tel: 0800 014 9111
Tel: +55 11 3688 9282
Fax: +55 11 3688 9421

Bulgaria (Sofia)

Tel: +359 2 981 4533
Fax: +359 2 980 0846

Canada (Montreal)

Tel: +1 514 332 5350
Fax: +1 514 332 0609

Chile (Santiago)

Tel: +56 2 471 4391
Fax: +56 2 471 4399

China (Beijing)

Tel: +86 10 5821 7788
Fax: +86 10 5821 7618

Colombia (Bogotá)

Tel: +57 1 417 8000
Fax: +57 1 413 4086

Costa Rica (San Jose)

Tel: +506 288 5484
Fax: +506 288 5482

Croatia (Zagreb)

Tel: +385 1 600 8550
Fax: +385 1 619 5111

Czech Republic (Prague)

Tel: +420 234 322 327
e-mail: motors&drives@cz.abb.com

Denmark (Skovlunde)

Tel: +45 44 504 345
Fax: +45 44 504 365

Dominican Republic (Santo Domingo)

Tel: +809 561 9010
Fax: +809 562 9011

Ecuador (Quito)

Tel: +593 2 2500 645
Fax: +593 2 2500 650

Egypt (Cairo)

Tel: +202 6251630
Fax: +202 6251638

El Salvador (San Salvador)

Tel: +503 2264 5471
Fax: +503 2264 2497

Estonia (Tallinn)

Tel: +372 6801 800
email: info@ee.abb.com

Ethiopia (Addis Abeba)

Tel: +251 1 669506, 669507
Fax: +251 1 669511

Finland (Helsinki)

Tel: +358 10 22 11
Tel: +358 10 222 1999
Fax: +358 10 222 2913

France (Montluel)

Tel: +33 (0)4 37 40 40 00
Fax: +33 (0)4 37 40 40 72

Germany (Ladenburg)

Tel: +01805 222 580 (Service)
Tel: +49 (0)6203 717 717
Fax: +49 (0)6203 717 600

Greece (Athens)

Tel: +30 210 289 1 651
Fax: +30 210 289 1 792

Guatemala (Guatemala City)

Tel: +502 363 3814
Fax: +502 363 3624

Hungary (Budapest)

Tel: +36 1 443 2224
Fax: +36 1 443 2144

India (Bangalore)

Tel: +91 80 2294 9585
Fax: +91 80 2294 9389

Indonesia (Jakarta)

Tel: +62 21 2551 5555
email: automation@id.abb.com

Iran (Tehran)

Tel: +98 21 2222 5120
Fax: +98 21 2222 5157

Ireland (Dublin)

Tel: +353 1 405 7300
Fax: +353 1 405 7312

Israel (Haifa)

Tel: +972 4 850 2111
Fax: +972 4 850 2112

Italy (Milan)

Tel: +39 02 2414 3085
Fax: +39 02 2414 3979

Ivory Coast (Abidjan)

Tel: +225 21 35 42 65
Fax: +225 21 35 04 14

Japan (Tokyo)

Tel: +81(0)3 5784 6010
Fax: +81(0)3 5784 6275

Jordan (Amman)

Tel: +962 6 562 0181
Fax: +962 6 5621369

Kazakhstan (Almaty)

Tel: +7 3272 583838
Fax: +7 3272 583839

Kenya (Nairobi)

Tel: +254 20 828811/13 to 20
Fax: +254 20 828812/21

Kuwait (Kuwait city)

Tel: +965 2428626 ext. 124
Fax: +965 2403139

Latvia (Riga)

Tel: +371 7 063 600
Fax: +371 7 063 601

Lithuania (Vilnius)

Tel: +370 5 273 8300
Fax: +370 5 273 8333

Luxembourg (Leudelange)

Tel: +352 493 116
Fax: +352 492 859

Macedonia (Skopje)

Tel: +389 23 118 010
Fax: +389 23 118 774

Malaysia (Kuala Lumpur)

Tel: +603 5628 4888
Fax: +603 5635 8200

Mauritius (Casablanca)

Tel: +230 208 7644, 211 8624
Fax: +230 211 4077

Mexico (Mexico City)

Tel: +52 (55) 5328 1400 ext. 3008
Fax: +52 (55) 5328 7467

Morocco (Casablanca)

Tel: +212 2224 6168
Fax: +212 2224 6171

The Netherlands (Rotterdam)

Tel: +31 (0)10 407 8886
e-mail: freqconv@nl.abb.com

New Zealand (Auckland)

Tel: +64 9 356 2170
Fax: +64 9 357 0019

Nigeria (Ikeja, Lagos)

Tel: +234 1 4937 347
Fax: +234 1 4937 329

Norway (Oslo)

Tel: +47 03500
e-mail: drives@no.abb.com

Oman (Muscat)

Tel: +968 2456 7410
Fax: +968 2456 7406

Pakistan (Lahore)

Tel: +92 42 6315 882-85
Fax: +92 42 6368 565

Panama (Panama City)

Tel: +507 209 5400, 2095408
Fax: +507 209 5401

Peru (Lima)

Tel: +51 1 561 0404
Fax: +51 1 561 3040

The Philippines (Metro Manila)

Tel: +63 2 821 7777
Fax: +63 2 823 0309, 824 4637

Poland (Lodz)

Tel: +48 42 299 3000
Fax: +48 42 299 3340

Portugal (Oeiras)

Tel: +351 21 425 6000
Fax: +351 21 425 6390, 425 6354

Qatar (Doha)

Tel: +974 4253888
Fax: +974 4312630

Romania (Bucharest)

Tel: +40 21 310 4377
Fax: +40 21 310 4383

Russia (Moscow)

Tel: +7 495 960 2200
Fax: +7 495 960 2201

Saudi-Arabia (Al Khobar)

Tel: +966 (0)3 882 9394, ext. 240,
254, 247
Fax: +966 (0)3 882 4603

Senegal (Dakar)

Tel: +221 832 1242, 832 3466
Fax: +221 832 2057, 832 1239

Serbia (Belgrade)

Tel: +381 11 3094 320, 3094 300
Fax: +381 11 3094 343

Singapore (Singapore)

Tel: +65 6776 5711
Fax: +65 6778 0222

Slovakia (Banska Bystrica)

Tel: +421 48 410 2324
Fax: +421 48 410 2325

Slovenia (Ljubljana)

Tel: +386 1 2445 440
Fax: +386 1 2445 490

South Africa (Johannesburg)

Tel: +27 11 617 2000
Fax: +27 11 908 2061

South Korea (Seoul)

Tel: +82 2 528 2794
Fax: +82 2 528 2338

Spain (Barcelona)

Tel: +34 (9)3 728 8700
Fax: +34 (9)3 728 8743

Sri Lanka (Colombo)

Tel: +94 11 2399304/6
Fax: +94 11 2399303

Sweden (Västerås)

Tel: +46 (0)21 32 90 00
Fax: +46 (0)21 14 86 71

Switzerland (Zürich)

Tel: +41 (0)58 586 0000
Fax: +41 (0)58 586 0603

Syrian Arab Republic

Tel: +9626 5620181 ext. 502
Fax: +9626 5621369

Taiwan (Taipei)

Tel: +886 2 2577 6090
Fax: +886 2 2577 9467, 2577 9434

Tanzania (Dar es Salaam)

Tel: +255 51 2136750, 2136751,
2136752
Fax: +255 51 2136749

Thailand (Bangkok)

Tel: +66 (0)2665 1000
Fax: +66 (0)2665 1042

Tunis (Tunis)

Tel: +216 71 860 366
Fax: +216 71 860 255

Turkey (Istanbul)

Tel: +90 216 528 2200
Fax: +90 216 365 2944

Uganda (Nakasero, Kampala)

Tel: +256 41 348 800
Fax: +256 41 348 799

Ukraine (Kiev)

Tel: +380 44 495 22 11
Fax: +380 44 495 22 10

The United Arab Emirates (Dubai)

Tel: +971 4 3147500, 3401777
Fax: +971 4 3401771, 3401539

United Kingdom (Daresbury, Warrington)

Tel: +44 1925 741 111
Fax: +44 1925 741 693

Uruguay (Montevideo)

Tel: +598 2 707 7300
Tel: +598 2 707 7466

USA (New Berlin)

Tel: +1 800 752 0696
Tel: +1 262 785 3200
Fax: +1 262 785 0397

Venezuela (Caracas)

Tel: +58 212 2031949
Fax: +58 212 237 6270

Vietnam (Hochiminh)

Tel: +84 8 8237 972
Fax: +84 8 8237 970

Zimbabwe (Harare)

Tel: +263 4 369 070
Fax: +263 4 369 084



ABB Oy
Drives
P. O. Box 184
FI - 00381 Helsinki
Finland
Telephone +358 10 22 11
Telefax +358 10 22 23764
Internet www.abb.com/motors&drives



441 024
Printed matter