

Extraction arms

ASA-4 arm - with alu \varnothing 160 and \varnothing 200 mm

GEOVENT ASA-4 extraction arm for welding fumes, grinding dust and fumes etc, where the operators needs are in focus when it comes to maneuverability, ergonomic and efficiency. The hose and ALU duct are mounted on the outside of the carrying arm, in order to let the air flow pass more freely resulting in the lowest possible pressure drop. The arm is mainly constructed in ALU parts, in order to keep the total weight down, which result in smooth operation. The arm has 3 stables and 3 turning points. The arm can be extended up to 8m by means of extension arms. The ASA4 is available in length of 2,0m, 3,0m, and 4,0m.

The ASA-4 arm is a duct arm with external carrying arm and aluminum duct with hose, see picture. ASA-4 has a lower pressure drop, than the ASA-3, but use and construction is basically almost the same as the ASA-3.

Description

Wall bracket: Steel console in powder enamel yellow RAL 1007. The console is turn able up to 270°.

Hood: Light weight aluminum hood in \varnothing 160 or \varnothing 200mm, which is equipped with an integrated ergonomic handle. The hood is as standard covered in powder enamel yellow RAL 1007. Move able in all possible positions.

Can be supplied in custom made colors upon request/ surcharge.

Arm and friction joints: 25x25 mm aluminum pipe, connected via joints with friction discs and plate springs. Inner arm part is reinforced with 30x30 mm EL-galvanized bracket and equipped with gas spring

Capacity: Up to 2.000 m³/h (depending on \varnothing diameter), which makes it suitable for all types of welding fumes and glue fumes, where large airflows are required.

Typical use: \varnothing 160 mm = 800-1.000 m³/h for MIG/MAG welding in black steel

\varnothing 200 mm = 800-1.000m³/h for MIG/MAG welding in stainless steel

Recommended installation height: min. 2.500 mm

ASA-4 - with duct

Art. No	Description	Weight
ASA4-2-160	2,0 m - \varnothing 160 mm	9 kg
ASA4-2-200	2,0 m - \varnothing 200 mm	10 kg
ASA4-3-160	3,0 m - \varnothing 160 mm	10 kg
ASA4-3-200	3,0 m - \varnothing 200 mm	11 kg
ASA4-4-160	4,0 m - \varnothing 160 mm	11 kg
ASA4-4-200	4,0 m - \varnothing 200 mm	12 kg



ASA-4 arm

Dimensions

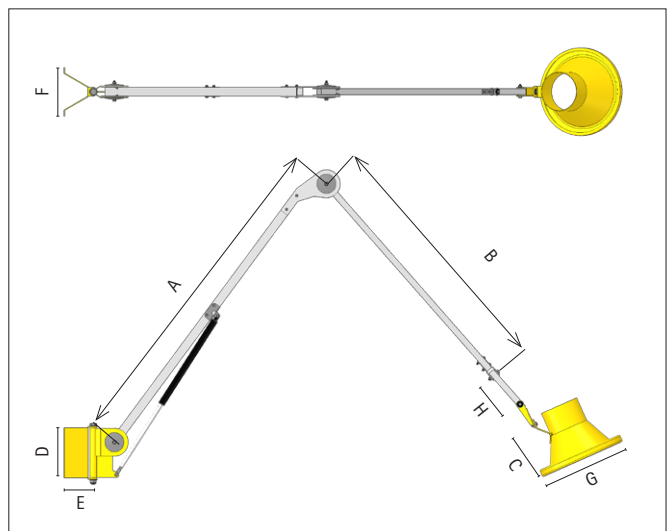

Arm	A [mm]	B [mm]	D [mm]	E [mm]	F [mm]
2,0 m	870	700	206	120	200
3,0 m	1370	1210	206	120	200
4,0 m	1865	1700	206	120	200

Hood	C [mm]	G [mm]	H [mm]
Hood \varnothing 80 mm	225	205	200
Hood \varnothing 100 mm	245	225	200
Hood \varnothing 125 mm	240	250	200
Hood \varnothing 160 mm	225	355	200
Hood \varnothing 200 mm	180	355	200

Pressure drop

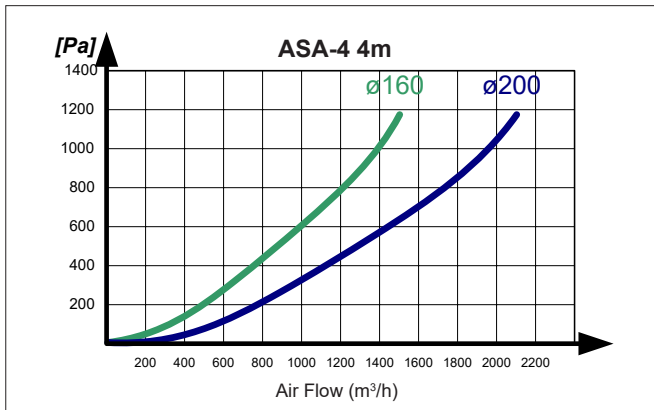
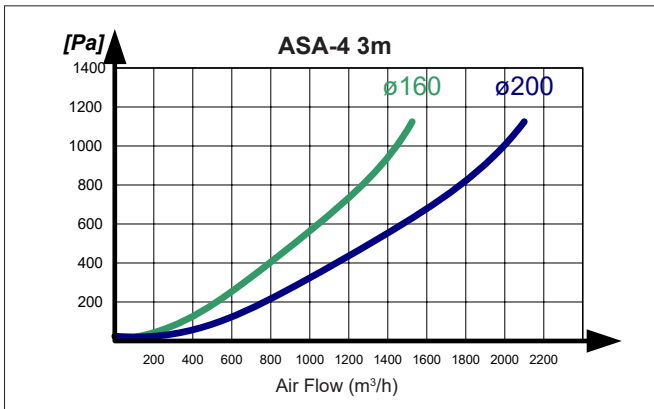
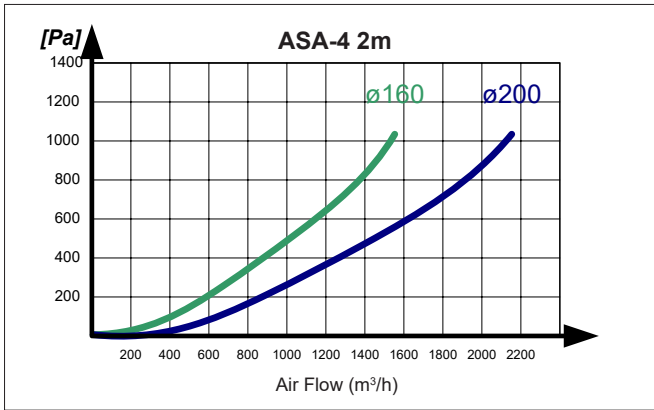

Dimensional drawing of the wall bracket

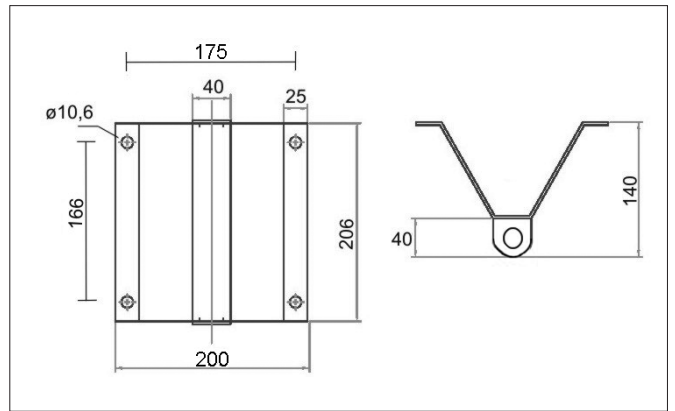

Dimensional drawing of the extension arm

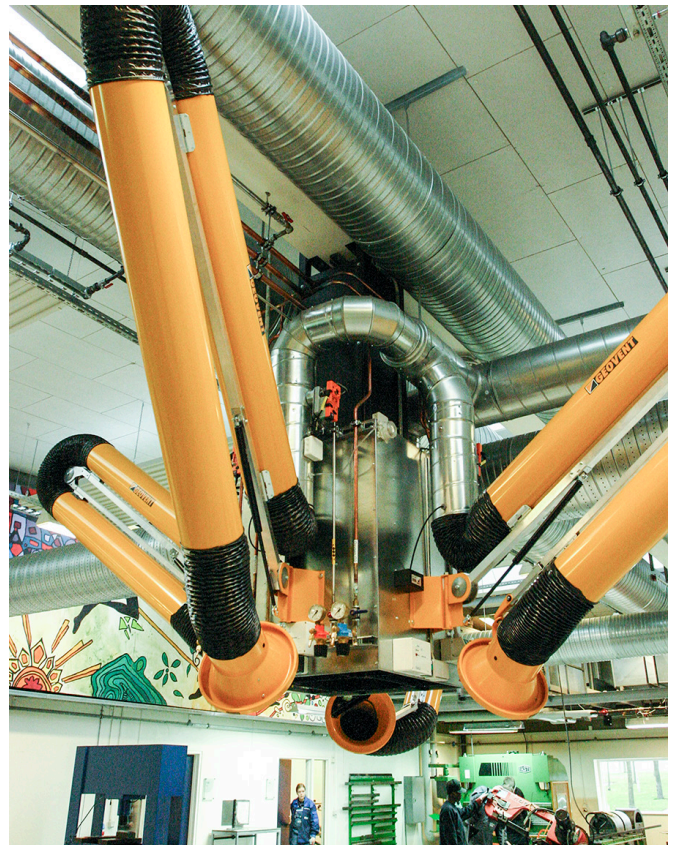
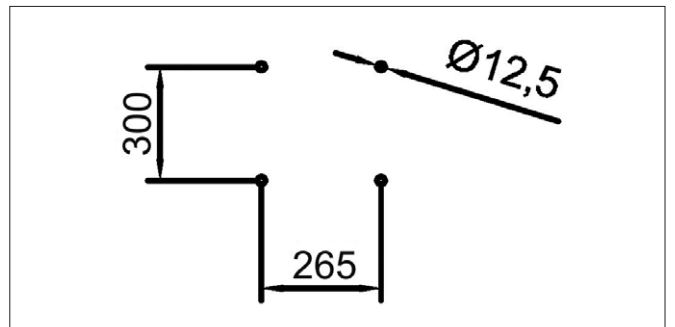

Special Solution