

## Extraction Arms

### ESA arm

The ESA arm is designed with an external support arm for easy positioning and low pressure drop. The support arm is made of extruded 6060 aluminum and the joints are of cast glass infused nylon. The arm joints are both supported with gas springs. The hood is made of aluminum for durability, and it is designed for maximum extraction and capture efficiency.

The ESA arm is available in  $\varnothing 160$  mm or  $\varnothing 200$  mm, in lengths from 2 to 5 meters. At 4 and 5 meters an extension is fitted to the wall. Using our standard extension arms the ESA Arm is available in up to 8 meters length.

#### Technical data

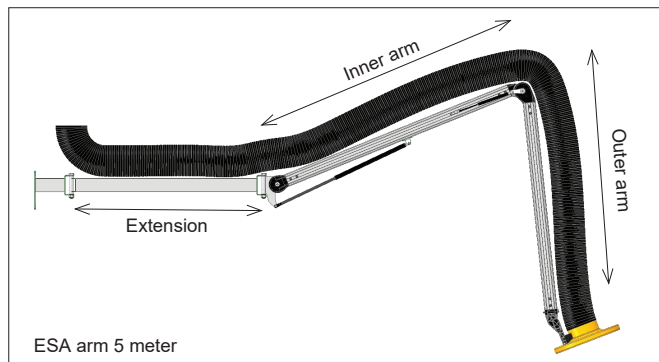

ESA Arm	Inner carrying arm (mm)	Outer carrying arm (mm)	Extension (mm)	Max. working radius (mm)	Max. Radius (mm)
2M	865	696		1600*	2000
3M	1365	1200		2700**	3000
4M	1365	1200	1000	3700**	4000
5M	1365	1200	2000	4700**	5000

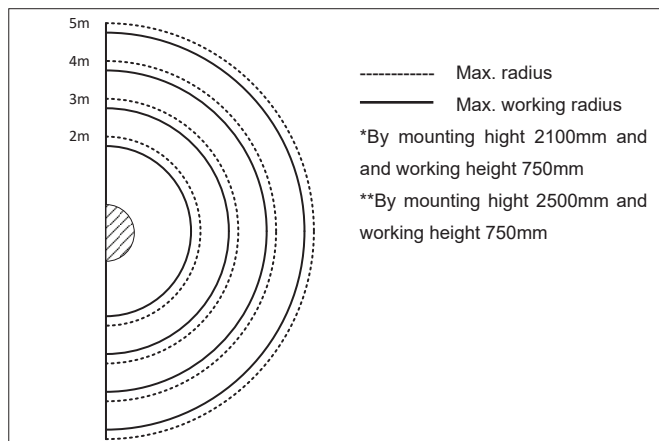

NB. By using the Extension the working area is limited



ESA arm 3 meter  $\varnothing 160$  mm

#### Ordering table

Art. No.	Description
01-650	ESA Arm 2,0m $\varnothing 160$ mm, complete arm incl. hose and wall bracket.
01-651	ESA Arm 3,0m $\varnothing 160$ mm, complete arm incl. hose and wall bracket.
01-652	ESA Arm 4,0m $\varnothing 160$ mm, complete arm incl. hose, wall bracket and extender.
01-653	ESA Arm 5,0m $\varnothing 160$ mm, complete arm incl. hose, wall bracket and extender.
01-660	ESA Arm 2,0m $\varnothing 200$ mm, complete arm incl. hose and wall bracket.
01-661	ESA Arm 3,0m $\varnothing 200$ mm, complete arm incl. hose and wall bracket.
01-662	ESA Arm 4,0m $\varnothing 200$ mm, complete arm incl. hose, wall bracket and extender.
01-663	ESA Arm 5,0m $\varnothing 200$ mm, complete arm incl. hose, wall bracket and extender.
01-680	Universal bracket (floor/ceiling) L=400-2500 mm
01-681	Ceiling bracket, swivel 360°
01-682	2-pin button for LED-set + on/off for fan
16-094	Motordamper-160 - se separat datablad
16-095	Motordamper-200 - se separat datablad
	Extension arm - se separat datablad

ESA arm

Working area - ESA arm 2 meter

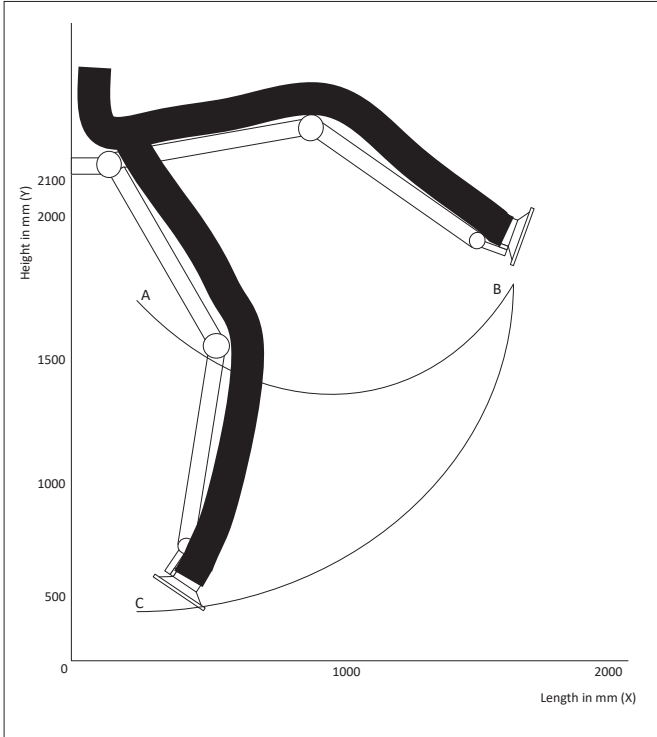

Working area - ESA arm 3, 4 and 5 meter

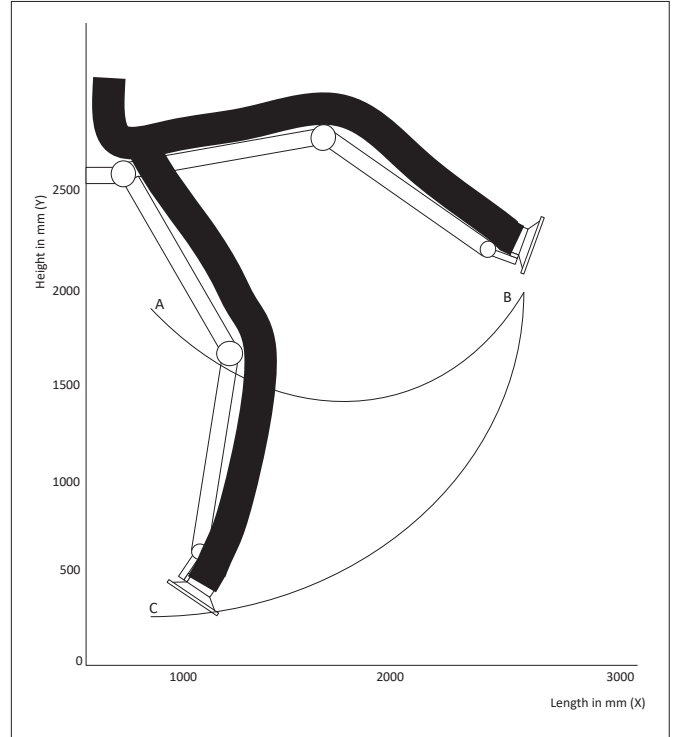

Arm lengths	A_X mm	A_Y mm	B_X mm	B_Y mm	C_X mm	C_Y mm
2M ESA arm	500	1550	1600	1700	500	600
3M ESA arm	500	1950	2700	2100	500	200
4M ESA arm	500	1950	3700	2100	500	200
5M ESA arm	500	1950	4700	2100	500	200

Dimensions

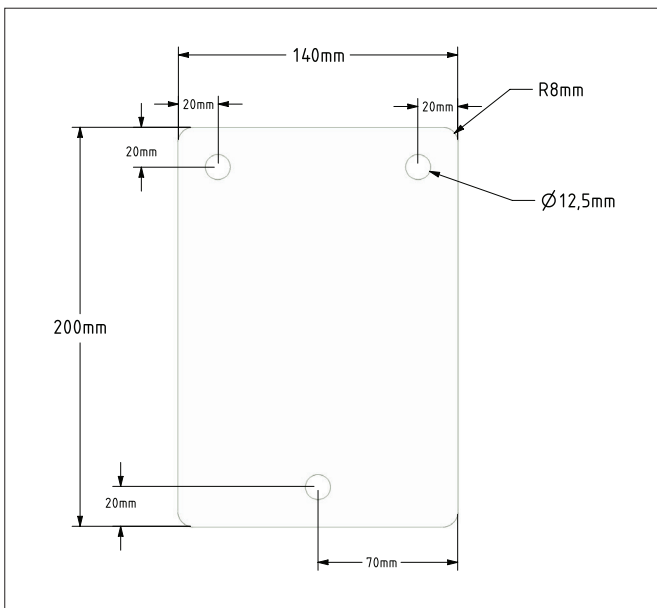

Wall bracket



ESA Arm with LED light in the hood

ESA arm



ESA arm mounted on ceiling bracket, swivel 180°



ESA arm mounted on ceiling bracket, swivel 360°

Dimensions

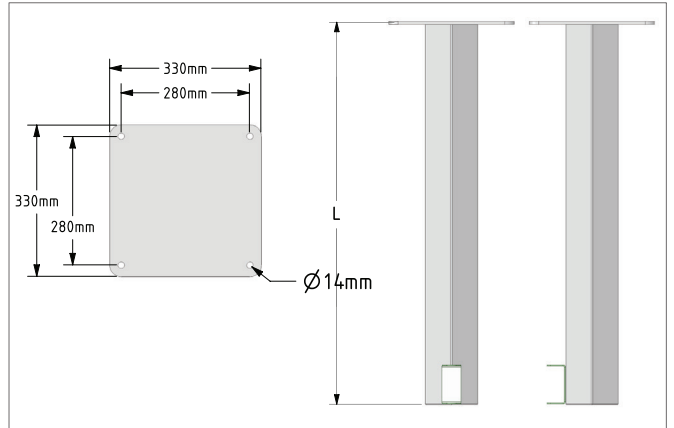

01-680 Wall bracket L=400-2500 mm. Only for use with ESA arm up to 5 meter.

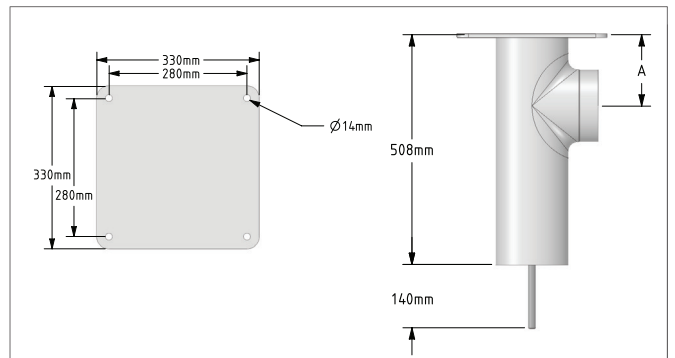

01-681 Wall bracket



ESA arm mounted on a ceiling bracket